

EXHAUST RAIL 26,2M

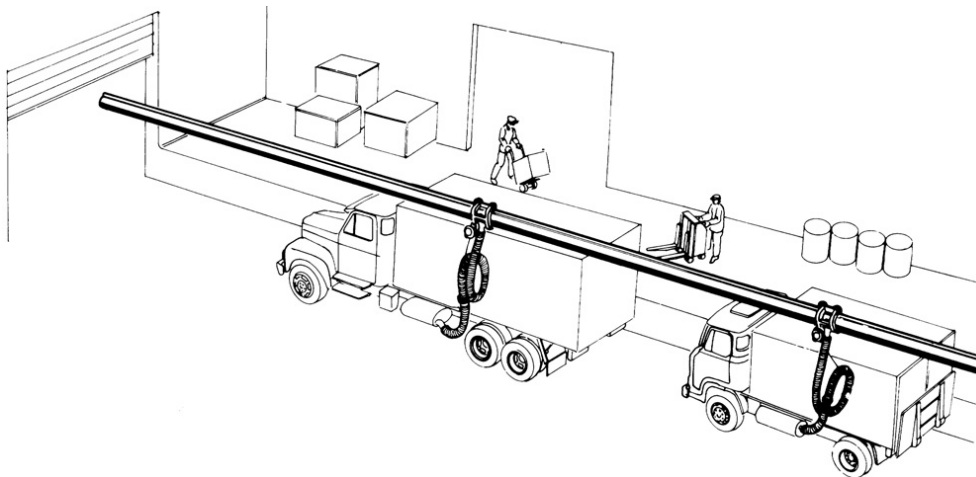

Part No
84534

TECHNICAL DATA

EXHAUST RAIL 26,2M

With wall brackets , connectors, rubber seal , end cover and trolley stop. Nozzles not included, order separately. We recommend nozzles with wise grip.

TECHNICAL DATA

Part No	84534
H.S. Code	76090000